

WSL系列 LED多功能警示灯

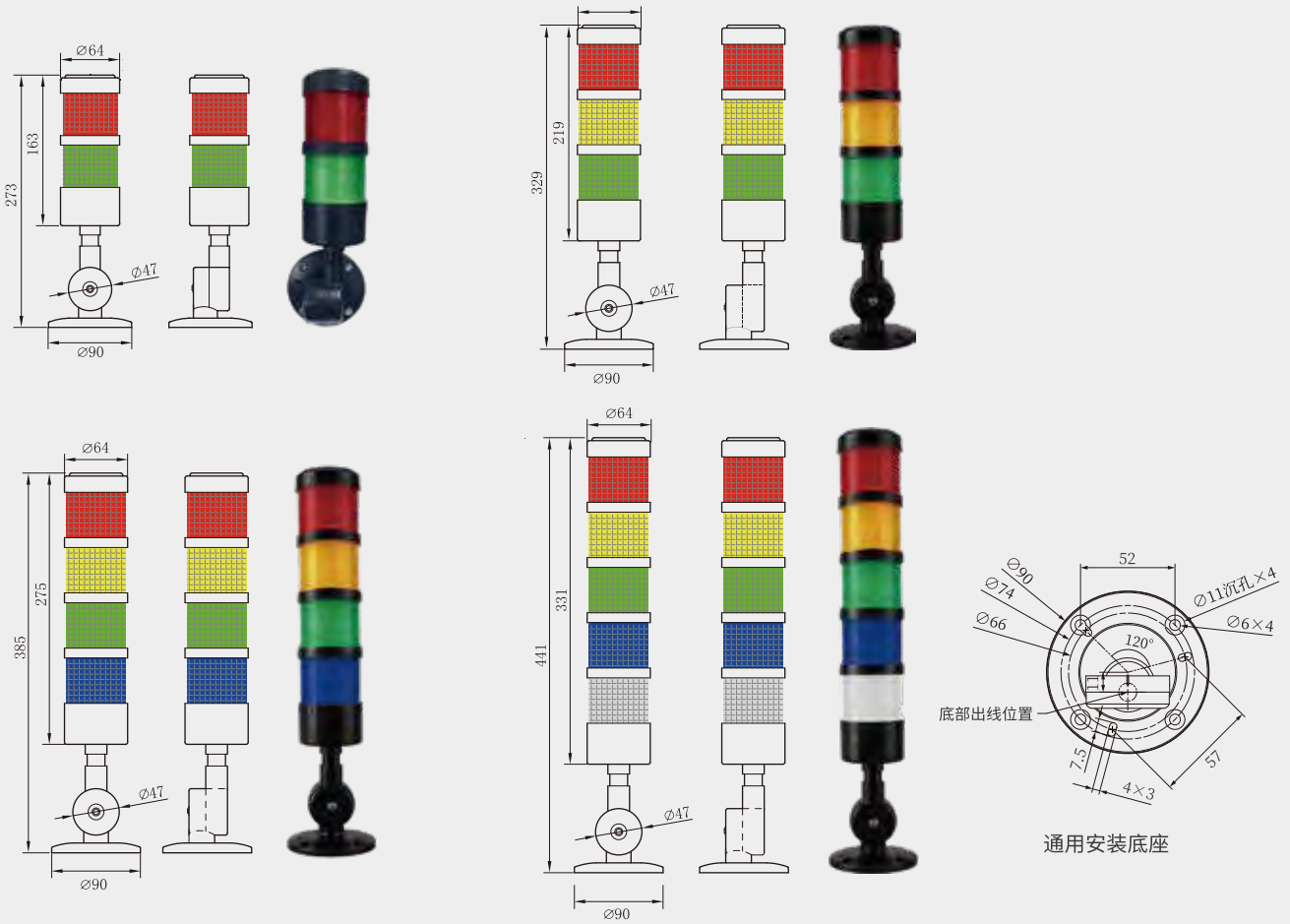

- IP20
- 24V
DC
- RYGBW
- M12
- 0.3m
- +55
-25
- 寿命
50000h
- ✕
- 360°

产品特点

- 高效LED多功能信号灯, 可满足各种需求, 性价比高
 - 混合棱镜切割灯罩大大提高了远距离的可视性能
- High-efficiency LED multi-function signal lamp, can meet various needs, high cost performance
 - Hybrid prism cutting lampshade greatly improves the visual performance at a long distance

产品规格型号示例

系列	安装	层数	额定电压	类型	接线方式	信号颜色
WSL	F	5	24	F	P	- RYGBW
	F=折叠式 S=直立式 F=Foldable S=Straight	2~5层 2~5Layers	24=DC24V	B=常亮 F=常亮带蜂鸣 B=Steady F=Steady with Buzzer	P= 共正极 N= 共负极	R=红色Red Y=黄色Yellow G=绿色Green B=蓝色Blue W=白色White

WSL系列LED多功能警示灯

产品参数

直径 Diameter	Ø64mm	寿命 Life-span	50000小时 50000h
壳体 Housing	PC、工程塑料 PC, plastic	灯罩材质 Lampshade Material	塑料、半透明 plastic, translucent
工作状态 Working Status	常亮/闪亮 Steady/Flashing	LED信号光源 Light Source	单色LED发光二极管 1 color of LEDS
声源 Sound Source	蜂鸣器“BBB……” Buzzer “BBB……”	光亮/音量可调 Dimmable/ Adjustable Volume	不可调 No
防护等级 Protection Degree	IP20	接线方式 Wire Connecting	共正极/共负极 Positive/Negative
额定电压 Nominal Voltage	DC 24V	延长线 Length of wire	300±15mm(标配) / M12 300±15mm(Standard configuration)/ M12
额定电流 Rated Current	单层多色	红光 0.07A 黄光 0.09A 绿光 0.06A 蓝光 0.06A 白光 0.06A 0.07A @Red 0.09A @Yellow 0.06A @Green 0.06A @Blue 0.06A @White	

产品尺寸图

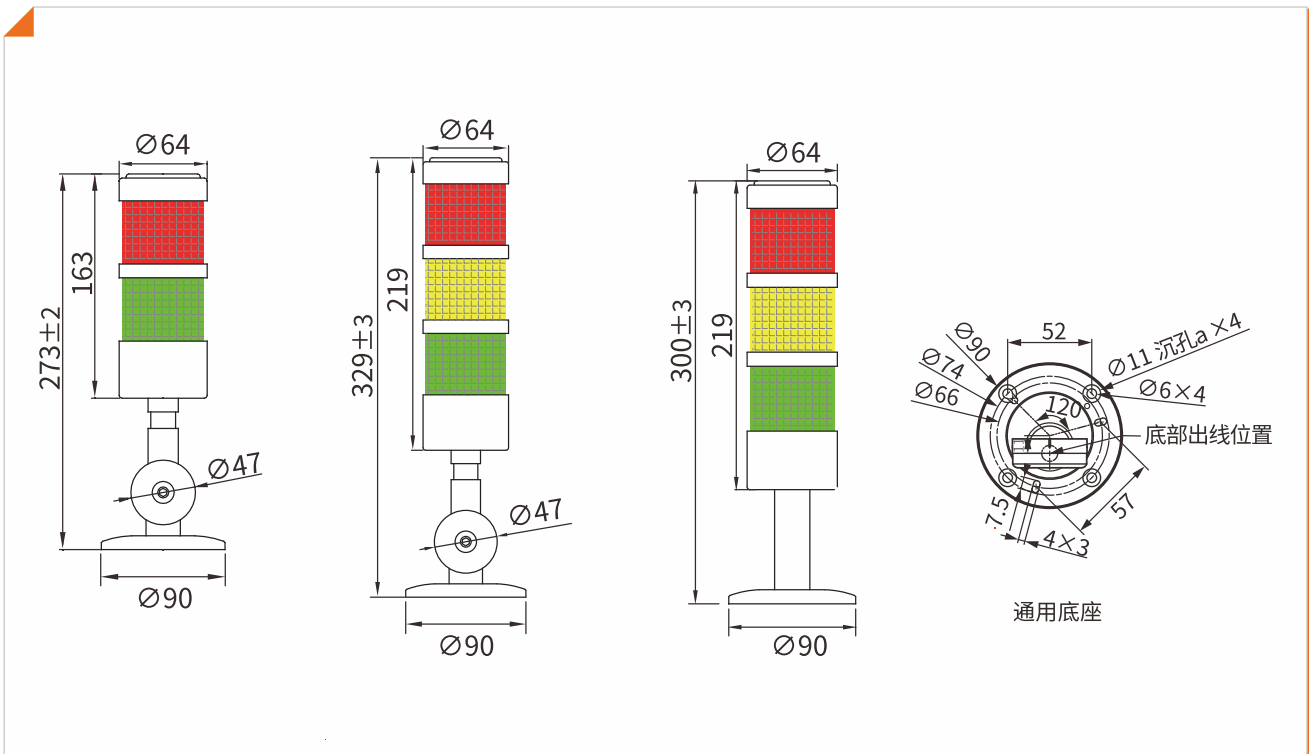

控制回路图

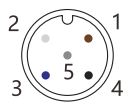
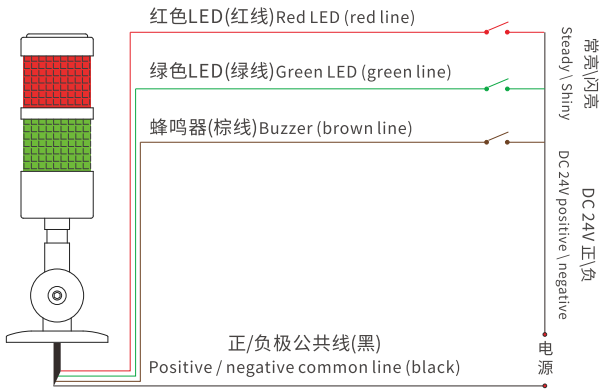

- #1棕=红灯RED LED
- #2白=蜂鸣器BUZZER
- #3蓝=公共线common line
- #4黑=绿灯GREEN LED
- #5灰=不连接not connected

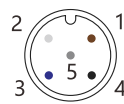
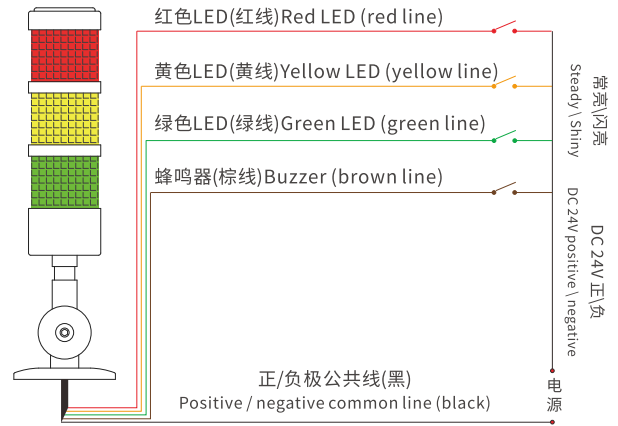

- #1棕=红灯RED LED
- #2白=蜂鸣器BUZZER
- #3蓝=公共线common line
- #4黑=绿灯GREEN LED
- #5灰=黄灯YELLOW LED

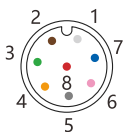
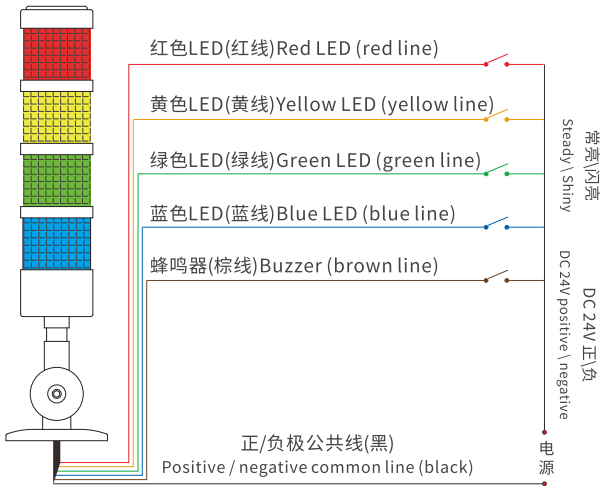

- #1白=绿灯GREEN LED
- #2棕=黄灯YELLOW LED
- #3绿=不连接not connected
- #4黄=不连接not connected
- #5灰=蓝灯BLUE LED
- #6粉=红灯RED LED
- #7蓝=公共线common line
- #8红=蜂鸣器BUZZER

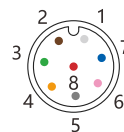
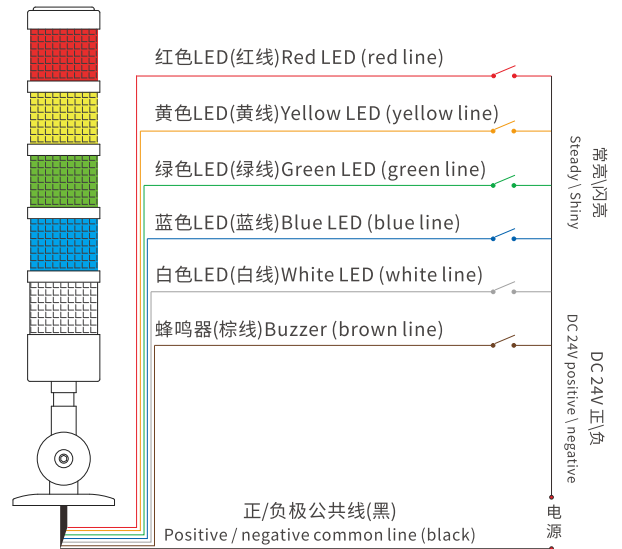

- #1白=绿灯GREEN LED
- #2棕=黄灯YELLOW LED
- #3绿=不连接not connected
- #4黄=白灯WHITE LED
- #5灰=蓝灯BLUE LED
- #6粉=红灯RED LED
- #7蓝=公共线common line
- #8红=蜂鸣器BUZZER

WSL系列LED多功能警示灯

颜色示例

对象 Item	控制 Control	警示 Warning	状况 Status
 红色灯 Red Light	RD	危险警示 Danger warning	报警发生 Alarm
 黄色灯 Yellow Light	YL	注意警示 Pay attention to the warning	运行准备状态 Prepare for running state
 绿色灯 Green Light	GN	安全提示 Safety tips	安全运行状态 Safety operation state
 蓝色灯 Blue Light	BU	强制干预 Mandatory intervention	需要手动复位 Manual reset
 白色灯 White Light	WT	—————	自定义状态 User-defined
连续音“BBB……” Continuant“BBB……”	BZ	—————	—————

故障处理

现象 Phenomenon	主要原因 Main reason	处理方法 Approach
无法工作 Can not work	错误接线 Incorrect wiring	再确认接线 Reconfirm the wiring
LED部分无法发光 The LED part cannot emit light	LED部分损伤 LED damage	更换LED Replace LED
模糊的长亮 Long blurry	使用比额定电压低的电压 Use a voltage lower than the rated voltage	确认使用电压 Confirm the use voltage

⚠ 使用注意事项

- 使用电压比额定电压严重上升会缩短使用寿命或工作不良的问题发生，要注意使用电压控制在±5%以内。
- 灯罩或身体上接触香蕉水等化学物质，产品表面会发生变形或变色的现象，要特别注意。
- 不要给产品施加强烈的冲击，会引起零部件的破损。
- 露出产品外部的电源线不能强行拉制，会引起产品故障。
- A serious increase in the use voltage compared to the rated voltage will shorten the service life or the problem of poor working. Please pay attention to the use voltage control within ± 5%.
- When the lampshade or the body is exposed to chemicals such as banana water, the surface of the product may be deformed or discolored. Pay special attention.
- Do not apply strong impact to the product, which may cause damage to parts.
- The power cord that is exposed outside the product cannot be forcibly drawn, which may cause product failure.